

### Silicon Carbide Schottky Diode

- Worlds first 600V Schottky diode
- Revolutionary semiconductor material - Silicon Carbide
- Switching behavior benchmark
- No reverse recovery
- No temperature influence on the switching behavior
- Ideal diode for Power Factor Correction up to 1200W<sup>F</sup>)
- No forward recovery

### Product Summary

$V_{RRM}$	600	V
$Q_C$	21	nC
$I_F$	6	A



Type	Package	Ordering Code	Marking	Pin 1	PIN 2	PIN 3
SDP06S60	P-TO220-3-1.	Q67040-S4371	D06S60	n.c.	C	A
SDB06S60	P-TO220-3.SMD	Q67040-S4370	D06S60	n.c.	C	A
SDT06S60	P-TO220-2-2.	Q67040-S4446	D06S60	C	A	

### Maximum Ratings, at $T_j = 25\text{ }^\circ\text{C}$ , unless otherwise specified

Parameter	Symbol	Value	Unit
Continuous forward current, $T_C=100^\circ\text{C}$	$I_F$	6	A
RMS forward current, $f=50\text{Hz}$	$I_{FRMS}$	8.4	
Surge non repetitive forward current, sine halfwave $T_C=25^\circ\text{C}$ , $t_p=10\text{ms}$	$I_{FSM}$	21.5	
Repetitive peak forward current $T_j=150^\circ\text{C}$ , $T_C=100^\circ\text{C}$ , $D=0.1$	$I_{FRM}$	28	
Non repetitive peak forward current $t_p=10\mu\text{s}$ , $T_C=25^\circ\text{C}$	$I_{FMAX}$	60	
$i^2t$ value, $T_C=25^\circ\text{C}$ , $t_p=10\text{ms}$	$\int I^2 dt$	2.3	A <sup>2</sup> s
Repetitive peak reverse voltage	$V_{RRM}$	600	V
Surge peak reverse voltage	$V_{RSM}$	600	
Power dissipation, $T_C=25^\circ\text{C}$	$P_{tot}$	57.6	W
Operating and storage temperature	$T_j, T_{stg}$	-55... +175	$^\circ\text{C}$

**Thermal Characteristics**

Parameter	Symbol	Values			Unit
		min.	typ.	max.	
<b>Characteristics</b>					
Thermal resistance, junction - case	$R_{thJC}$	-	-	2.6	K/W
Thermal resistance, junction - ambient, leaded	$R_{thJA}$	-	-	62	
SMD version, device on PCB:	$R_{thJA}$				
P-TO263-3-2: @ min. footprint		-	-	62	
P-TO263-3-2: @ 6 cm <sup>2</sup> cooling area <sup>F)</sup>		-	35	-	
P-TO252-3-1: @ min. footprint		-	-	75	
P-TO252-3-1: @ 6 cm <sup>2</sup> cooling area <sup>F)</sup>		-	-	50	

**Electrical Characteristics, at  $T_j = 25\text{ }^\circ\text{C}$ , unless otherwise specified**

Parameter	Symbol	Values			Unit
		min.	typ.	max.	
<b>Static Characteristics</b>					
Diode forward voltage	$V_F$				V
$I_F=6\text{A}, T_j=25\text{ }^\circ\text{C}$		-	1.5	1.7	
$I_F=6\text{A}, T_j=150\text{ }^\circ\text{C}$		-	1.7	2.1	
Reverse current	$I_R$				$\mu\text{A}$
$V_R=600\text{V}, T_j=25\text{ }^\circ\text{C}$		-	20	200	
$V_R=600\text{V}, T_j=150\text{ }^\circ\text{C}$		-	50	1000	

<sup>1</sup>CCM,  $V_{IN}=85\text{VAC}$ ,  $T_j=150\text{ }^\circ\text{C}$ ,  $T_C=100\text{ }^\circ\text{C}$ ,  $\eta=93\%$ ,  $\Delta I_{IN}=30\%$

<sup>2</sup>Device on 40mm\*40mm\*1.5mm epoxy PCB FR4 with 6cm<sup>2</sup> (one layer, 70  $\mu\text{m}$  thick) copper area for drain connection. PCB is vertical without blown air.

Electrical Characteristics, at  $T_j = 25\text{ }^\circ\text{C}$ , unless otherwise specified

Parameter	Symbol	Values			Unit
		min.	typ.	max.	
<b>AC Characteristics</b>					
Total capacitive charge $V_R=400\text{V}$ , $I_F=6\text{A}$ , $di_F/dt=200\text{A}/\mu\text{s}$ , $T_j=150\text{ }^\circ\text{C}$	$Q_C$	-	21	-	nC
Switching time $V_R=400\text{V}$ , $I_F=6\text{A}$ , $di_F/dt=200\text{A}/\mu\text{s}$ , $T_j=150\text{ }^\circ\text{C}$	$t_{rr}$	-	n.a.	-	ns
Total capacitance $V_R=0\text{V}$ , $T_C=25\text{ }^\circ\text{C}$ , $f=1\text{MHz}$ $V_R=300\text{V}$ , $T_C=25\text{ }^\circ\text{C}$ , $f=1\text{MHz}$ $V_R=600\text{V}$ , $T_C=25\text{ }^\circ\text{C}$ , $f=1\text{MHz}$	$C$	-	300 20 15	-	pF

**1 Power dissipation**

$P_{tot} = f(T_C)$

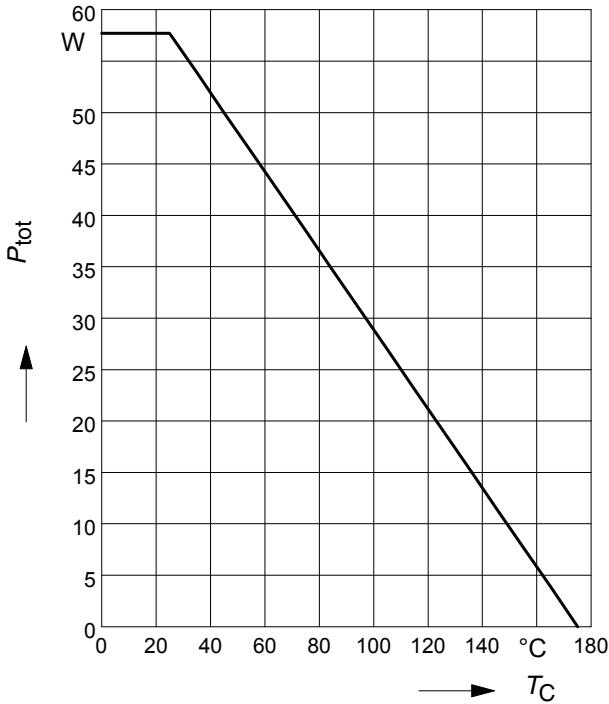

**2 Diode forward current**

$I_F = f(T_C)$

parameter:  $T_j \leq 175^\circ\text{C}$

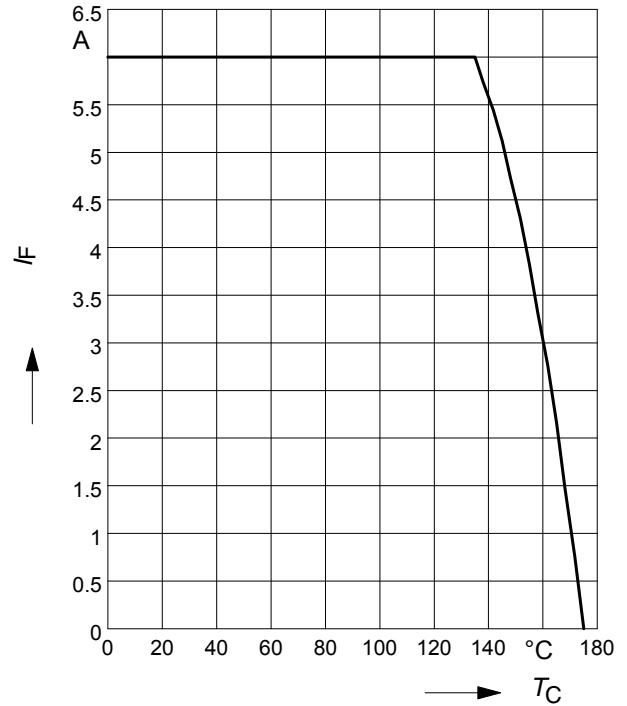

**3 Typ. forward characteristic**

$I_F = f(V_F)$

parameter:  $T_j, t_p = 350 \mu\text{s}$

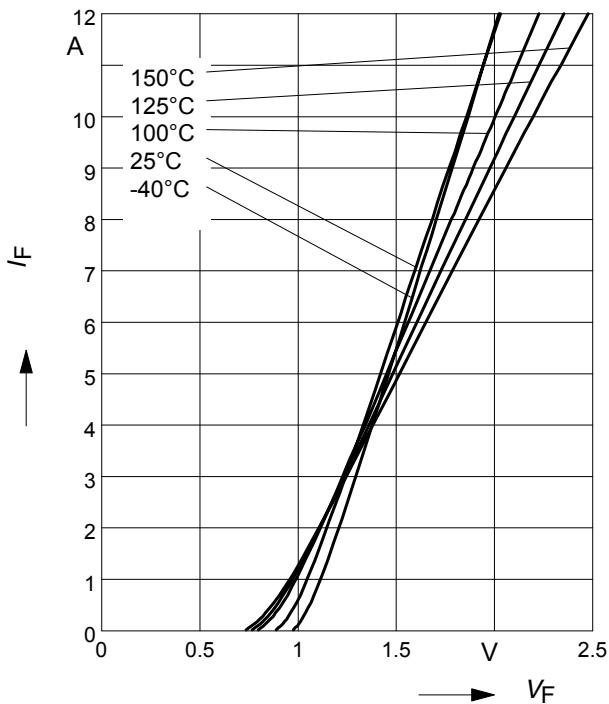

**4 Typ. forward power dissipation vs. average forward current**

$P_{F(AV)} = f(I_F) \quad T_C = 100^\circ\text{C}, d = t_p/T$

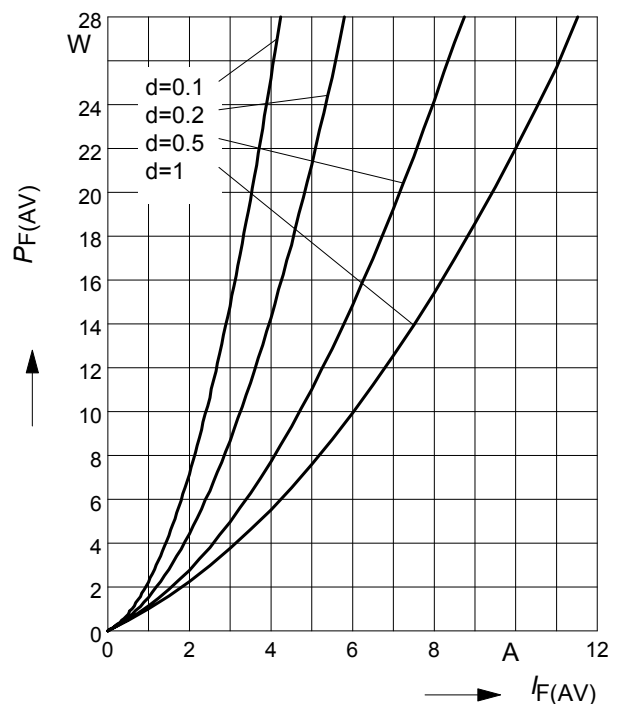

**5 Typ. reverse current vs. reverse voltage**

$$I_R = f(V_R)$$

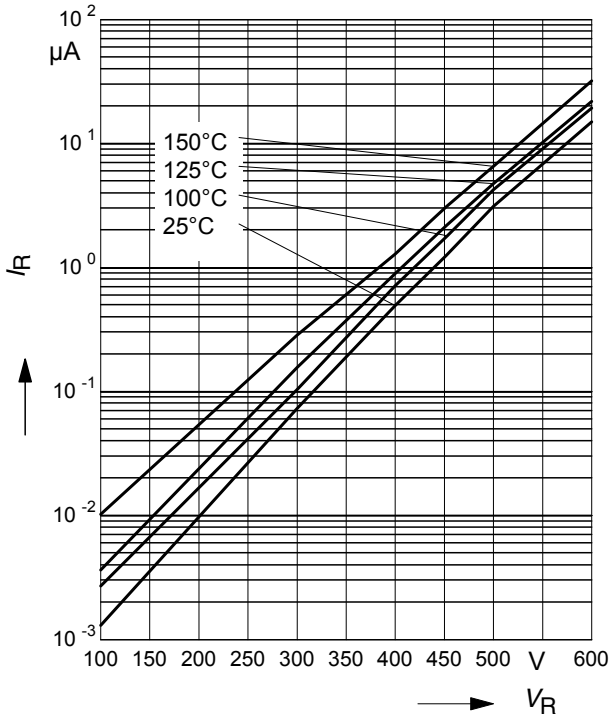

**6 Transient thermal impedance**

$$Z_{thJC} = f(t_p)$$

parameter :  $D = t_p/T$

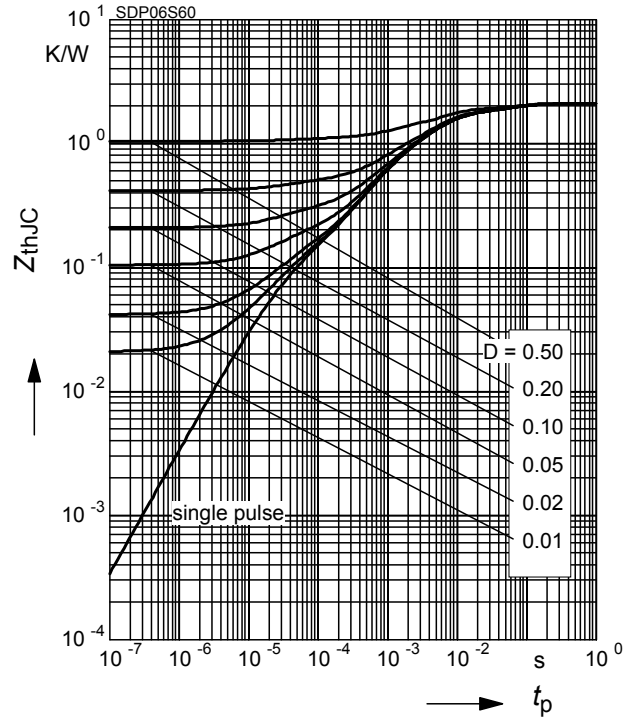

**7 Typ. capacitance vs. reverse voltage**

$$C = f(V_R)$$

parameter:  $T_C = 25\text{ }^\circ\text{C}$ ,  $f = 1\text{ MHz}$

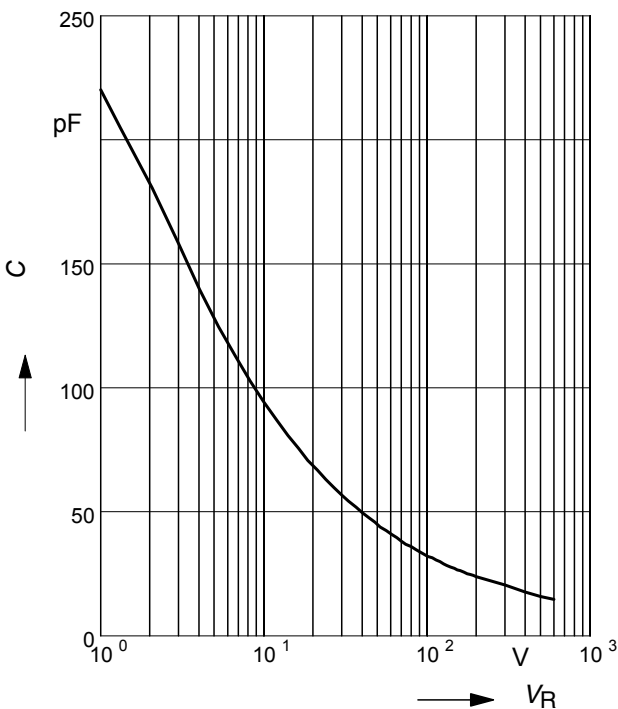

**8 Typ. C stored energy**

$$E_C = f(V_R)$$

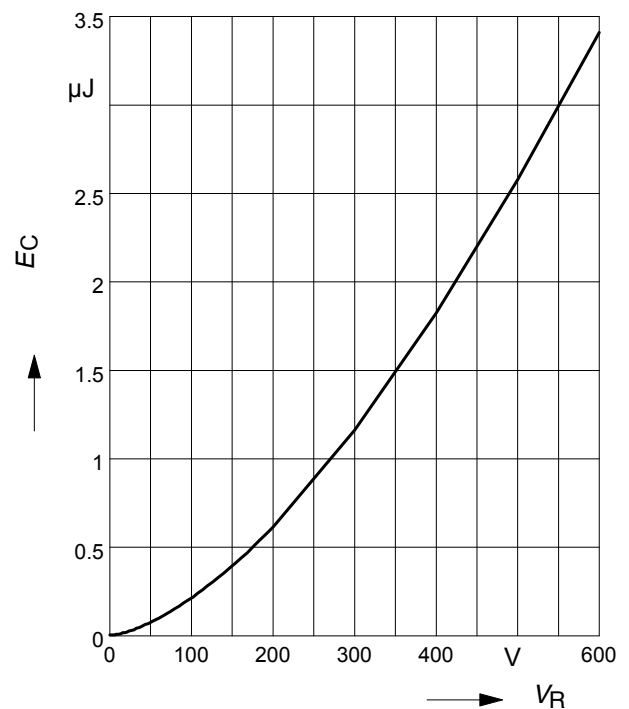

9 Typ. capacitive charge vs. current slope

$$Q_c = f(di_F/dt)$$

parameter:  $T_j = 150\text{ }^\circ\text{C}$

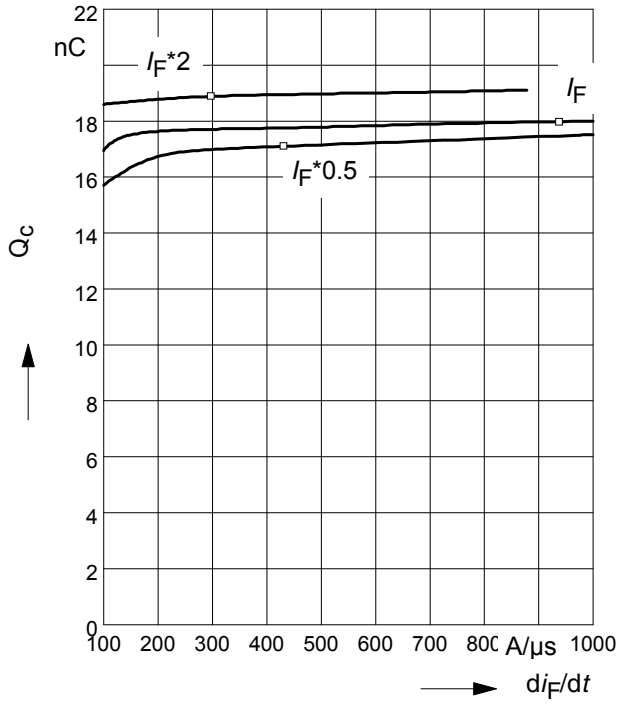

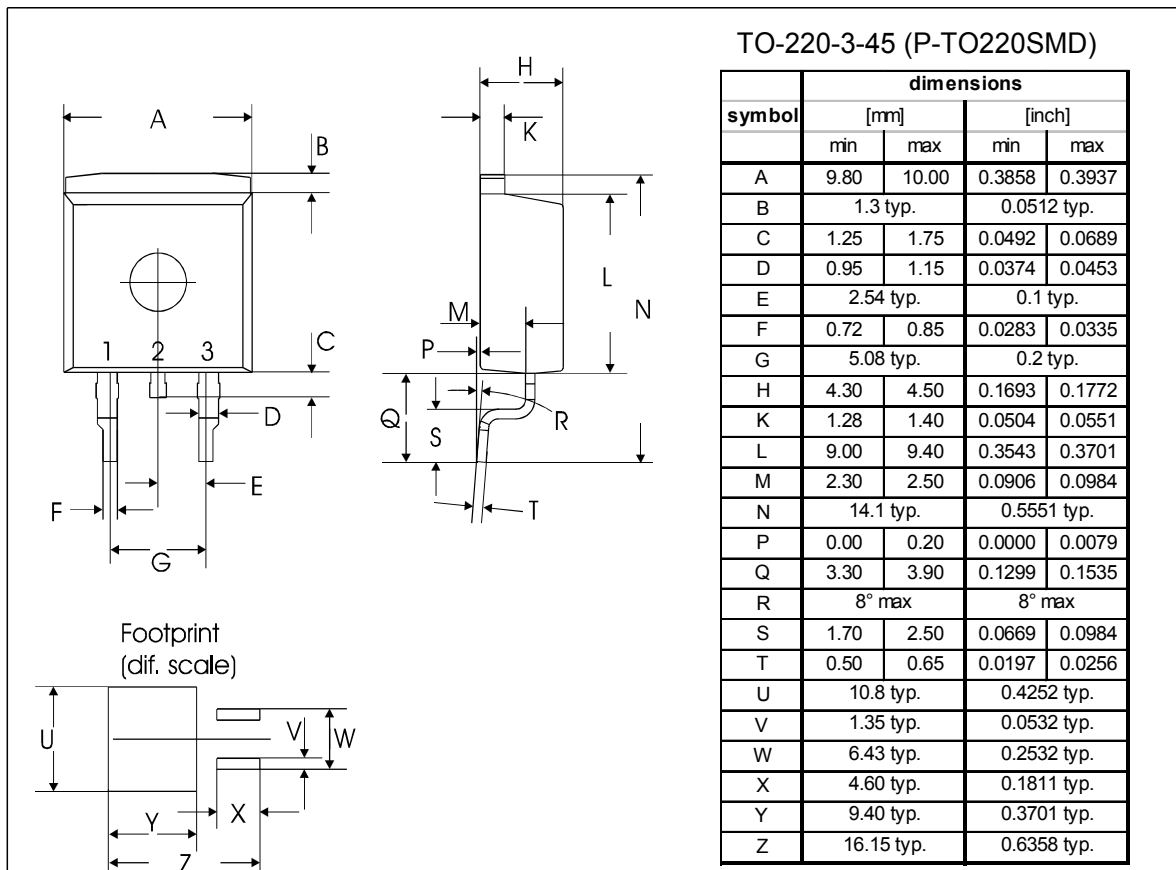
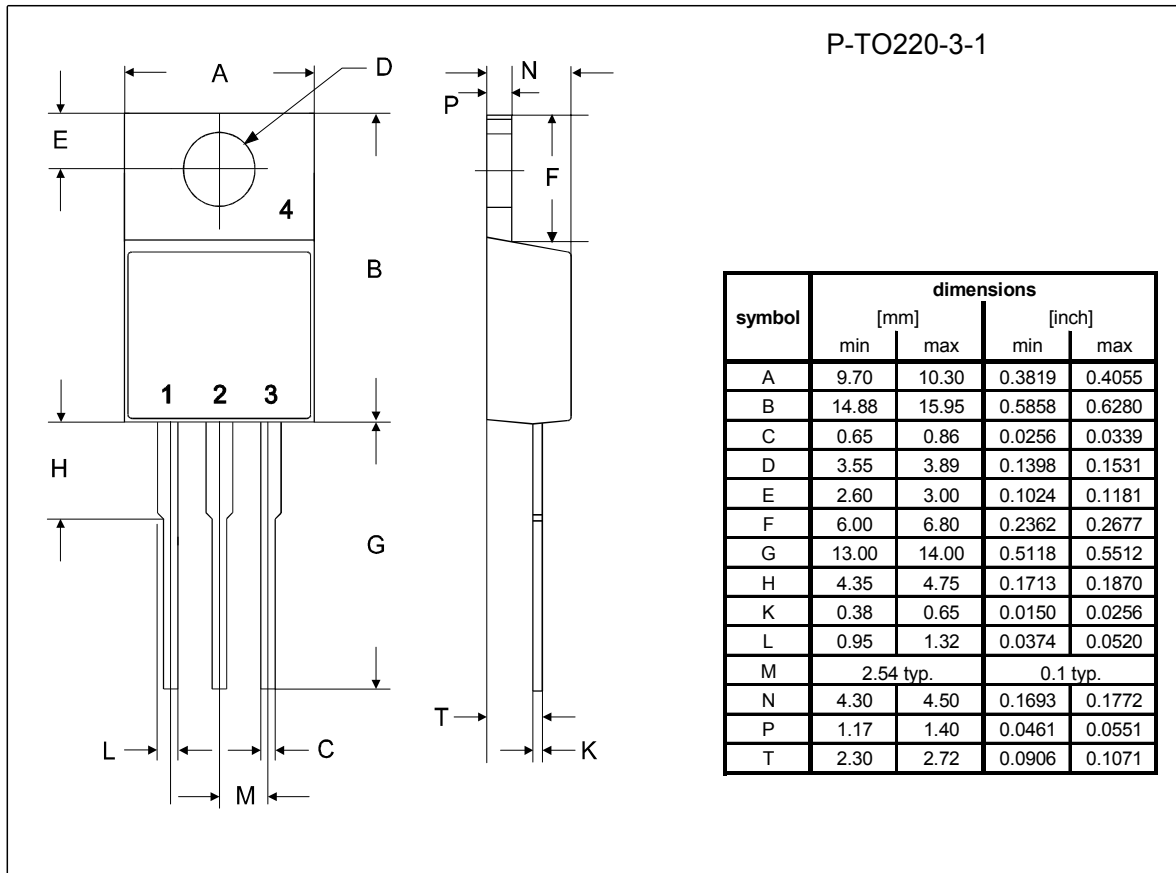

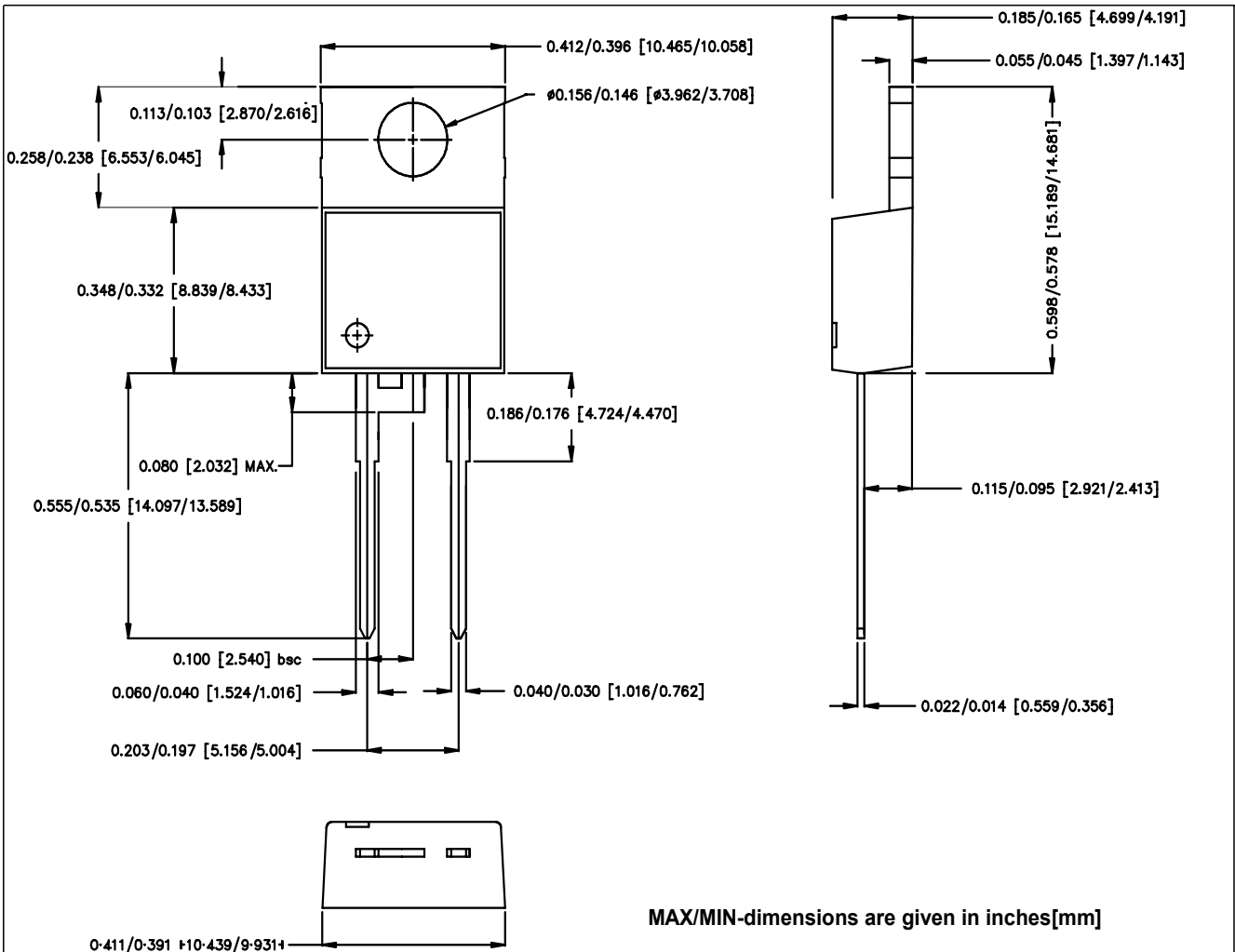



**Published by**  
**Infineon Technologies AG,**  
**Bereichs Kommunikation**  
**St.-Martin-Strasse 53,**  
**D-81541 München**  
**© Infineon Technologies AG 1999**  
**All Rights Reserved.**

**Attention please!**

The information herein is given to describe certain components and shall not be considered as warranted characteristics.

Terms of delivery and rights to technical change reserved.

We hereby disclaim any and all warranties, including but not limited to warranties of non-infringement, regarding circuits, descriptions and charts stated herein.

Infineon Technologies is an approved CECC manufacturer.

**Information**

For further information on technology, delivery terms and conditions and prices please contact your nearest Infineon Technologies Office in Germany or our Infineon Technologies Representatives worldwide (see address list).

**Warnings**

Due to technical requirements components may contain dangerous substances.  
For information on the types in question please contact your nearest Infineon Technologies Office.

Infineon Technologies Components may only be used in life-support devices or systems with the express written approval of Infineon Technologies, if a failure of such components can reasonably be expected to cause the failure of that life-support device or system, or to affect the safety or effectiveness of that device or system. Life support devices or systems are intended to be implanted in the human body, or to support and/or maintain and sustain and/or protect human life. If they fail, it is reasonable to assume that the health of the user or other persons may be endangered.